

# Installation Manual

(For undertile heating element)



Please read the ENTIRE Installation Manual before attempting to do the installation. Incorrect installation could damage the cable and therefore make your warranty invalid

## Contents

3	Do's & Don'ts	
4	Simple steps to luxurious warmth	
5	Do not damage the heating element.	
6	Sizing Guide	
7	Configuration Notes	
8	Prewiring of Electrical Installation	
9	Technical Notes	
10	Calculate the actual spacing of the heating element.	
11	<b>Installation Steps 1-10</b>	<b>Page</b>
	• Floor Preparation - <b>Step 1</b>	11
	• Mark the floor for element position - <b>Steps 2 &amp; 3</b>	12
	• Lay out heating element and secure with fixing tape- <b>Steps 4 &amp; 5</b>	13
	• Cover with screed and test the heating element - <b>Steps 6 &amp; 7</b>	16
	• Connection and testing of the continuity alarm - <b>Step 8</b>	17
	• Tiling - <b>Step 9</b>	18
	• Controller connection - <b>Step 10</b>	19
20	Tiler Instructions	
22	Product Warranty	

Your Warmtech Undertile Heater has been designed so that installation is quick and straight forward, but as with all electrical systems, certain procedures must be strictly followed.



### Kit contents

- Warmtech Undertile Heating element including element continuity alarm
- Adhesive spray
- Adhesive tape
- Thermal screed
- Controller
- Manual

Warmtech Heating Systems accepts no liability, expressed or implied for any loss or consequential damage suffered as a result of installations which in any way contravene the instructions that follow.

If these instructions are followed, you should have no problems. However if you do require help at any stage, please call our Free helpline:

**Warmtech helpline: 1300 138 126**

You can also find a copy of this manual, wiring instructions, a list of frequently asked questions and more helpful information on our website: [www.warmtech.com.au](http://www.warmtech.com.au).

## Do and don'ts

- DO** carefully read this installation manual before commencing installation.
- DO** ensure the floor surface is clean and dry before proceeding.
- DO** plan the wire layout and stick to recommended wire spacing and perimeters.
- DO** Space the element evenly over the floor.
- DO** Plan post-tiling drilling (eg for fixing sanitary ware, door stops) so as not to damage the wiring.
- DO** maintain a gap between heating wire runs of at least 50mm at all times.
- DO** make sure that ALL the element wire is positioned under the tiles in the installation.
- DO** Protect the element with cardboard or hardboard between installation and tiling.
- DO** use tile adhesives and grouts suitable for use with underfloor heating. (Check with Warmtech)
- DO** check that the heater is working immediately before commencing tiling.
- DO** take particular care when tiling not to dislodge or damage the heater element.
- DO** Ensure that each tile is solidly bedded in the adhesive, with no gaps or voids.
- DO** If in doubt about the suitability of the sub-floor to be heated, check with your local tile shop, tiler or call the Warmtech technical helpline.

- DON'T** cut or attempt to shorten the element wire at any time.
- DON'T** commence installation on a concrete floor that has not fully cured.
- DON'T** allow traffic over the installed heater before tiling.
- DON'T** remove the heating element from the spool other than during installation.
- DON'T** allow the heating wires to cross over or touch each other at any point.
- DON'T** store tiles, sharp or heavy objects on any of the wiring whilst tiling.
- DON'T** commence tiling before testing the Warmtech Heating System using the cable alarm.
- DON'T** switch on the installed heating system until tile adhesive has fully dried - 7 days minimum.
- DON'T** install the heating wire on stairways or up the walls.

### Warning

Once the heating wire has been installed avoid all traffic over the wire until the floor has been covered by sand and cement. Do not install the heating wire until the floor is ready to be tiled.

Immediately prior to tiling, test the heating wires as specified on page 13 to check it has not been damaged. If you are in any doubt, call the Warmtech helpline on 1300 138 126.

# Simple Steps to Luxurious Warmth

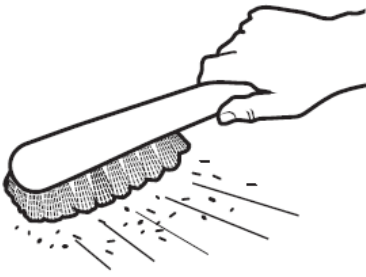

Prepare the floor

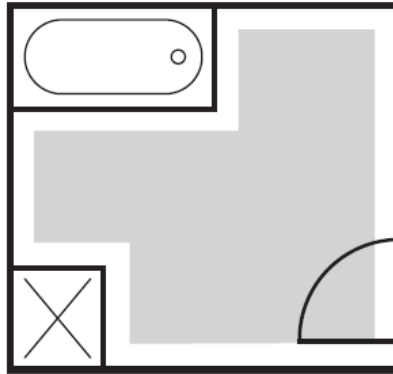

Mark the floor area to be heated

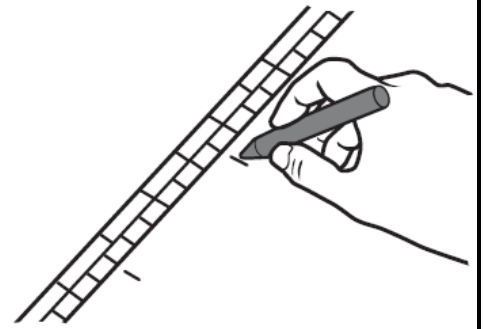

Mark the floor for the heater position

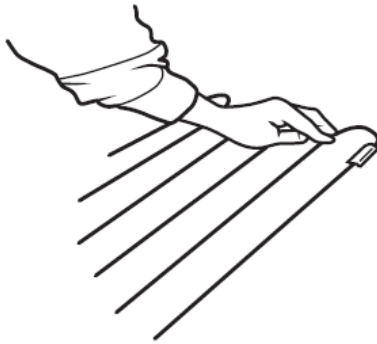

Lay out the wire

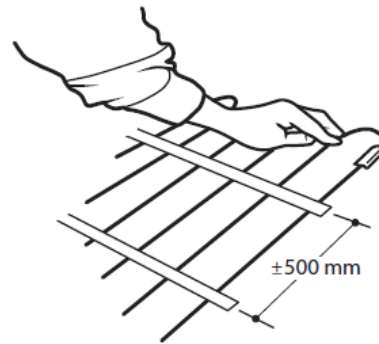

Secure the wire with tape

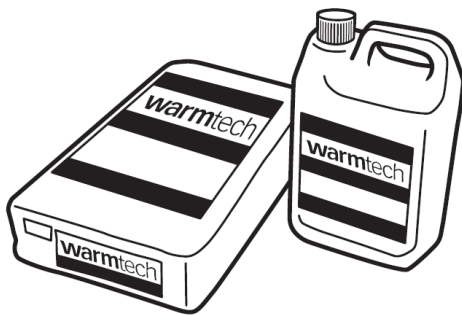

Apply the thermal screed



Connect and test the continuity alarm

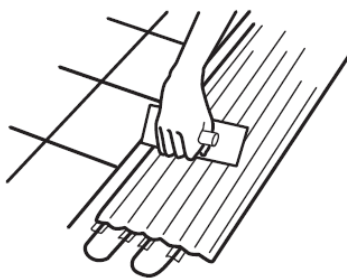

Tiling

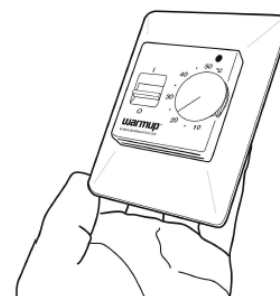

Connect the thermostat

## **DO NOT DAMAGE THE HEATING ELEMENT**

Your Warmtech Undertile heating element is one continuous resistance wire with electrical conducting wires connected to each end. **It must not be cut, shortened or lengthened.** Once the heater has been installed, avoid all traffic over the heating element until the floor has been tiled. If the floor is not being tiled immediately, a sheet of cardboard or hardboard should be laid over the heater as interim protection.

Immediately prior to tiling **Test the Heater** to check that it is working (specified on Page 16 ).

**IF THE HEATER IS NOT WORKING DO NOT COMMENCE TILING,  
CALL WARMTECH : 1300 138 126.**

Please check the sizing guide to ensure that you have the correct heater(s) for the area you wish to heat.

## Sizing Guide

For larger or different area sizing - please contact the Warmtech technical helpline on 1300 138 126.

Element	Total Ohms (@ 20 °C)	Cable Length	Coverage in sqm (at wire centers of ...(mm) ± 10%			Power Density (watts per sqm) ± 5%		
			60	85	100	60	85	100
UT200	264 ohms	16.5m	0.90	1.22	1.42	222	163	140
UT300	176 ohms	25.0m	1.29	1.79	2.09	232	167	144
UT400	132 ohms	33.5m	1.76	2.45	2.86	227	163	140
UT500	105 ohms	41.5m	2.18	3.06	3.57	229	164	140
UT650	82 ohms	54.0m	2.91	4.07	4.76	223	159	136
UT800	66 ohms	66.5m	3.60	5.06	5.91	223	159	136
UT1000	52 ohms	83.5m	4.56	6.41	7.50	219	156	133
UT1250	42 ohms	105.0m	5.82	8.18	9.58	216	154	132
UT1500	33 ohms	125.0m	6.96	9.79	11.47	215	153	131
UT2000	25 ohms	166.5m	9.37	13.19	15.46	211	150	128
UT2500	21 ohms	208.5m	11.85	16.69	19.56	214	152	129
UT3000	16 ohms	250.0m	14.31	20.14	23.61	210	149	127

Notes:

These are nominal specifications only.

Coverage table is by calculation only - actual wire layout on the floor may have an effect on the actual coverage obtained. The table shows the area in sqm that any cable will cover at various wire centres eg if a UT1000 is laid up with the runs 85mm apart, a total heated area of 6.41sqm should be achieved.

The power density table shows the watts per sqm of the heated area - the higher the power density the greater the temperature rise on the tiled surface.

## Configuration Notes

Whilst the installation instructions only make provision for the heating elements to be installed in a set configuration, there are many instances where departure from this configuration may be desirable. Below are a few drawings illustrating such instances:

Standard room

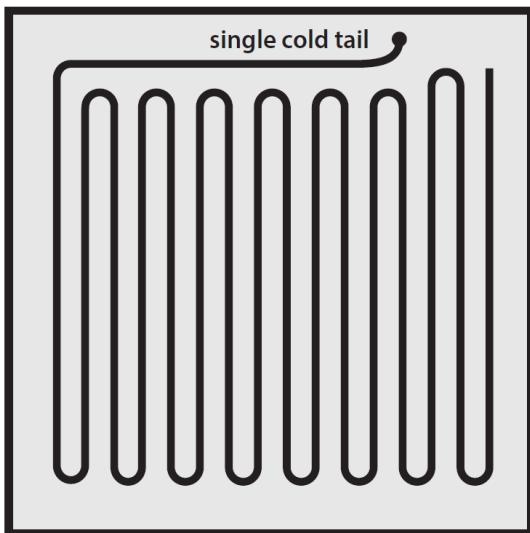

Room with recesses

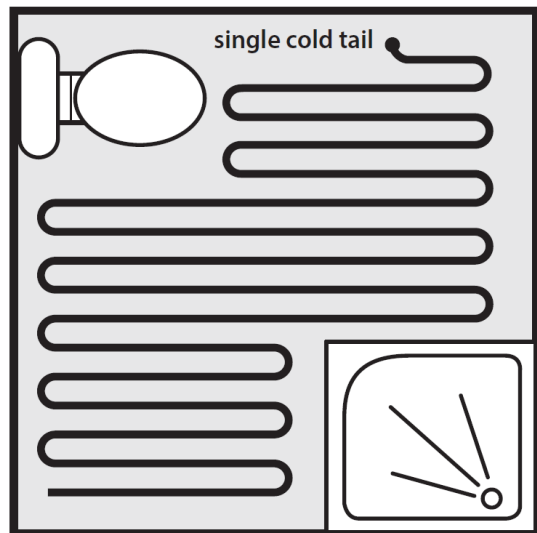

Room with central obstacle

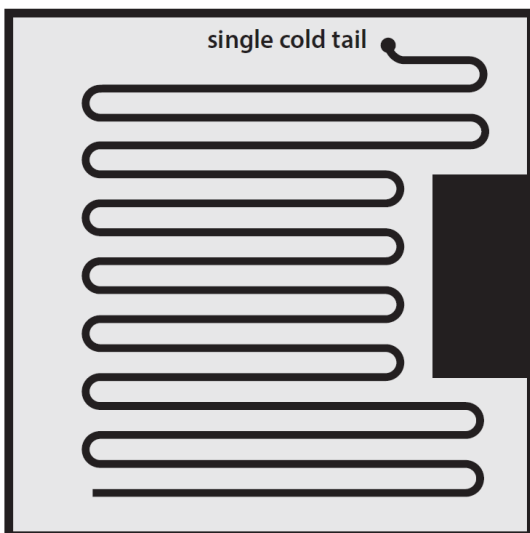

Bathroom

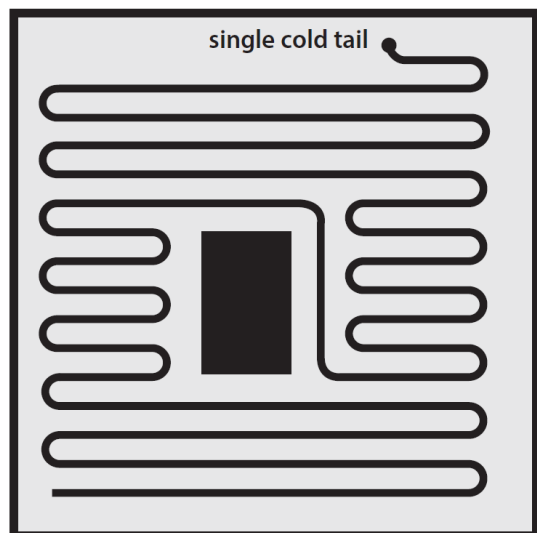

In each of the above examples, the floor space is heated using different wire configurations to suit the particular layout of the room. Most layouts will differ with every job.

# Pre-wiring of Electrical Installation - Wall mounted thermostat

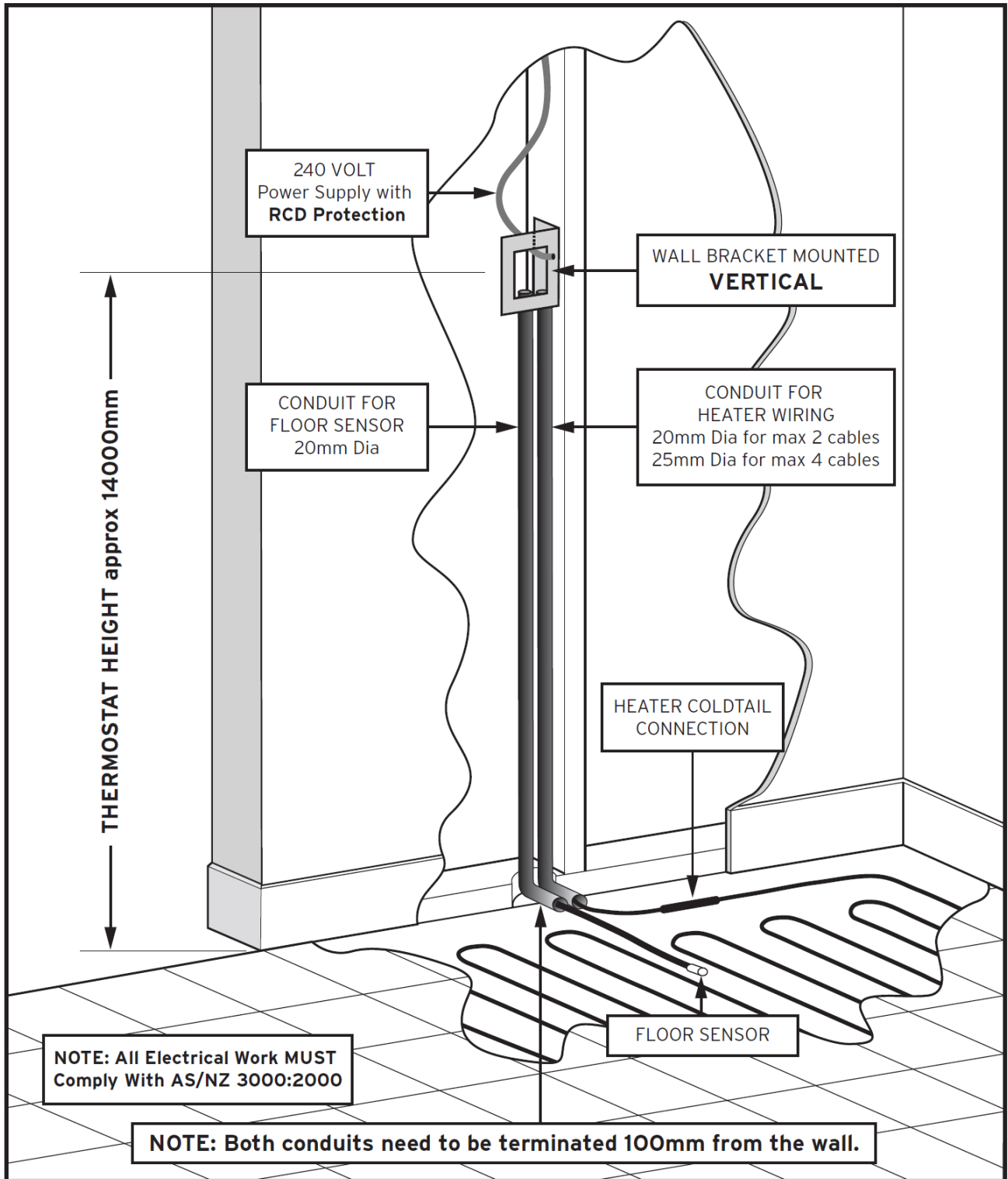

In 'Ultra Thin' heating applications the floor will need to be chased to allow the sensor tube and cold tails to be recessed into the floor. Once in place you need to glue it down.

**Before water proofing** chase the floor to allow the floor sensor and cold tails to sit flush with floor level. Measure room and according to your supplied 'Design Layout' chase the floor at the both cold tails (5mm), and sensor tube location (12mm).

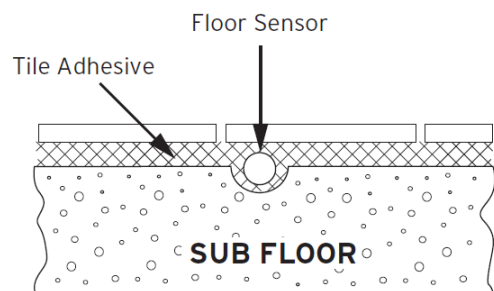

Ultra-Thin Chase Option



To fully utilize the long-term durability of your tiles, whether heated or not, it is important that the design and construction of the sub floor is carried out correctly.

The sub floor **must** be sufficiently rigid to support the ultimate weight that it will have to bear without movement or deflection. Wherever a timber sub floor is to be heated and tiled it is ***strongly recommended*** that a fibre cement sheet is installed prior to heating and tiling.

Waterproofing (if required) or movement control joints should be done prior to the installation.

The installation should comply with the following Codes of Practice:

**Electrical Codes of Practice AS/NZS 3000:2000**

The choice of products for sub floor preparation and tile fixing will vary depending on the existing sub floor, preferred tiling system and choice of tile.

If in doubt please consult with your tiler, tile supplier or adhesive supplier.

## Calculate the actual spacing of the heating element on the floor

1. Work out the actual sqm to be heated (see grey shaded area) i.e. **3.53sqm.**

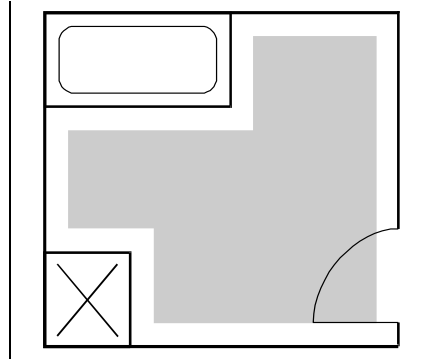

2. Divide this figure by the length of the wire to be used per the sizing guide

$$3.53\text{m}^2 \div 41.5\text{m} = \mathbf{0.085}.$$

3. Multiply this figure by 1000.  $0.085 \times 1000 = \mathbf{85\text{mm}}$  apart is your wire spacing.

### Summary:

$$\frac{3.53\text{m}^2}{41.5\text{m of wire}}$$

$$= 0.085 \times 1000 = 85\text{mm apart}$$

### Helpful Hints:

- The element is a continuous wire that must not be shortened or lengthened. Even spacing of the wire will ensure an even temperature of your tiles.
- The adhesive spray ensures that the adhesive tape holds in place. Allow 10 minutes for curing before attempting to adhere tape.
- All the elements are marked with a halfway marker for an indication of how your installation is progressing.
- For a successful long installation life, your floor should be clean, dry and stable (wooden floors) or fully cured (concrete floors).

## Step 1 - Floor Preparation

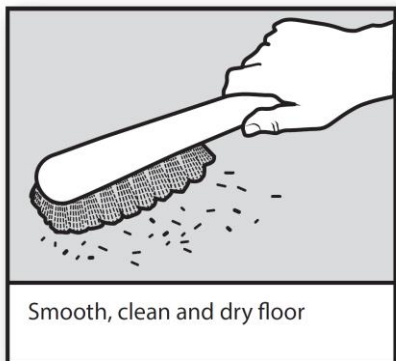

Smooth, clean and dry floor

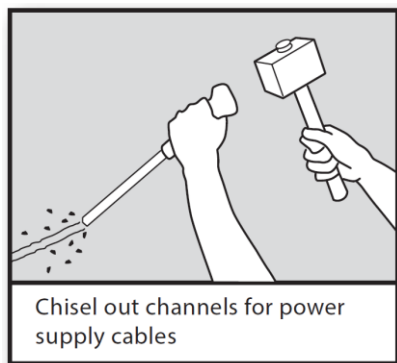

Chisel out channels for power supply cables

- As a general rule if your floor has been suitably prepared for tiling then it will be suitably prepared for undertile heating.
- If the heater is being fitted to a solid concrete floor, it is essential that the concrete is fully cured (as per manufacturers specifications) before the heating is installed.
- Before beginning the installation, ensure that the floor surface is smooth, dry and free from dust or grease.
- To ensure a flat floor surface, it will be necessary to chisel out or “chase” short channels in the sub floor at the ‘start point’ (see steps 4 and 5), and the ‘end point’. This minimises the increased height presented by the two black power supply cables. The start and end points of the heating element should be at least 50mm apart (no closer) or maximum 100mm (see sizing guide).
- **Never cross over any of the heating elements (check sizing guide for colours).**

The lowest ambient temperature at which the heating element may be installed is 0°. Heating elements shall be installed at a distance of at least 30mm from conductive parts of the building, such as water pipes.

## Steps 2 and 3 - Mark the floor for element position

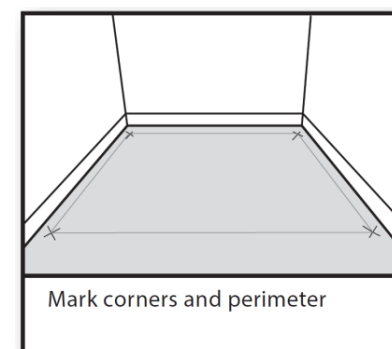
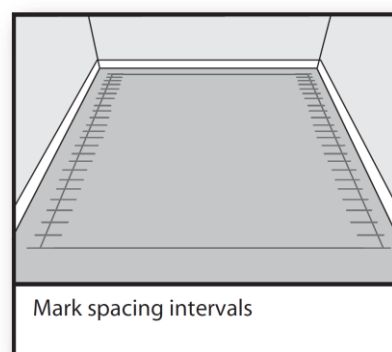
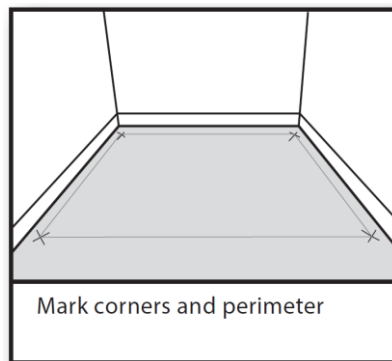
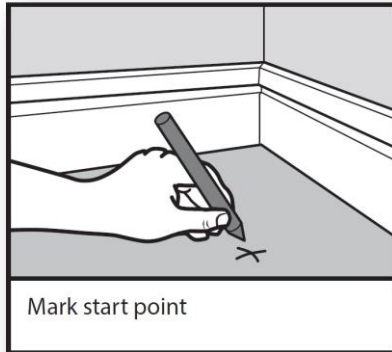
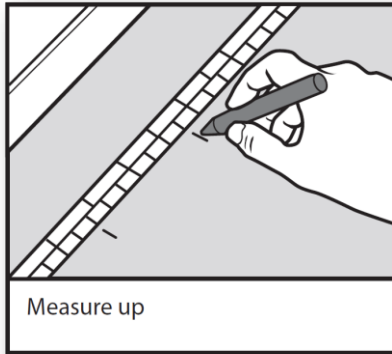

- Calculate in square metres the **actual size** of the area to be heated. Then, using the sizing/calculation guide on pages 6 and 10, establish the **actual element spacings**.
- Using a fibre tipped pen mark a start point *no further* than 1.50m from the power supply. The start point should be positioned as close as possible to the power supply.
- Mark all the outer corners of the heated area observing the perimeter distances and join the corners up to form a marked out perimeter.
- Mark up the spacing intervals for the element wire following the sizing guide plus your actual calculation. **The spacing interval between the element wires must be at least 50mm apart. The maximum spacing interval that is recommended is 100mm.**
- Spray the floor with the adhesive spray along areas where the cable loops around, or where the element will require taping in place. The spray adhesive acts as a primer for the tape and should only be used where the element is to be taped to the floor. Allow to cure for approximately 10 minutes.

## Installation Step 4 and 5 - Lay out heating element and secure with fixing tape.

Once the floor has been marked up, the element wire can be laid out.

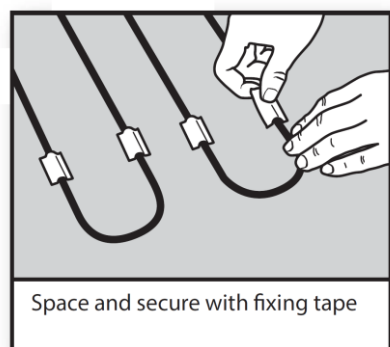
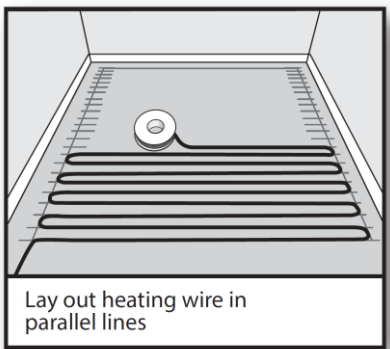
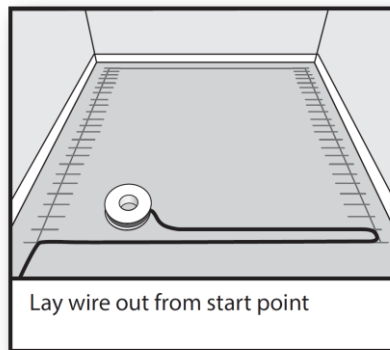
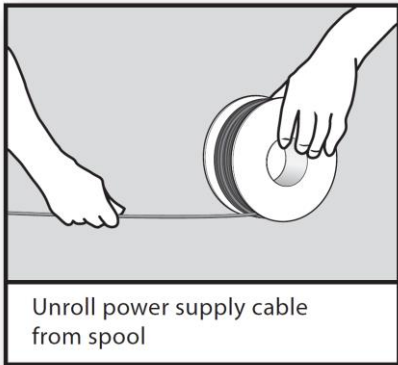

- Gently unroll the power supply cable from the spool. After 3 metres of black cable has been removed, you will reach the point at which the power supply cable joins the heating element wire (which is of a different colour).
- The join of the power supply cable and the heating cable should be taped to the floor at the start point (which is the first of the chiselled channels).
- Following the perimeter markings on the floor, lay out the heating element wire, taping down at each corner. The element wire should run from the **start point** in a U shape to the furthest corner from the start point.
- Once the element wire has been laid out around the perimeter, start laying out the heater wire in parallel lines back and forth across the main body of the area to be heated.
- Using the spacing markings, tape down the element to the floor with strips of the adhesive tape (which has been supplied) over the pre sprayed areas. The tape strips should be about 25mm (1 inch) long.
- You will also note a  $\frac{1}{2}$  way marker indicating that you have used up  $\frac{1}{2}$  the length of the heating element. Check the coverage of the floor already completed to gauge your end result.

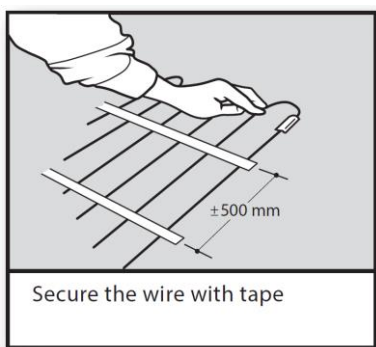
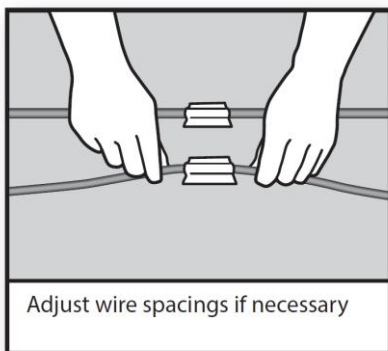
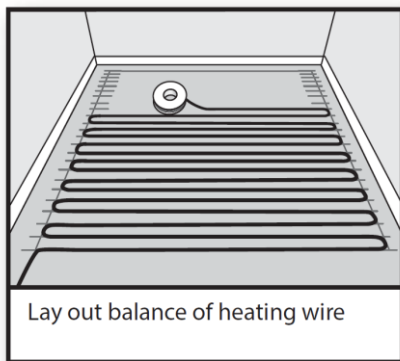
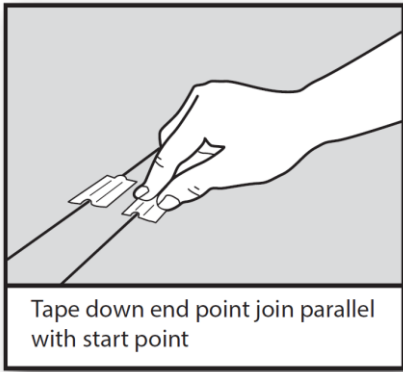

- When you have completed about 90% of the element layout, gently unroll the remaining wire and the second power supply cable (black) from the spool. At the end point where the power supply cable meets the heating element you will find another join. Tape this join to the **end point** (which is the second chiselled channel), at least 50mm apart from the start point join that you taped down previously.
- You will be left with a coil of unsecured element. This unsecured element should be laid out in reverse order i.e. starting from the end point and working backwards to the last point at which the element was taped down.
- In order to achieve even coverage of the balance of the area to be heated, you may at this stage need to adjust some of the element spacing that you previously secured.
- This can be achieved by untaping a few of the previous runs of element that you taped down, and re-fixing them at wider or narrower intervals. You may wish to alter the element layout to fit your particular requirements. Where there are irregularities of shape you can lay out the element to provide warmth around toilets, etc.

This is quite acceptable provided that:

- a. The element is spaced at least 50mm apart at all times. Not closer.
  - b. The element should never cross over.
  - c. Never allow the heating element to be within the wall cavity, the black 'power supply leads' only.
- Once the laying of the element is complete meaning the black leads are both back to the starting point, these will need to be carefully pulled up within the wall cavity using the draw wire.
  - If the standard controller has been upgraded to include a floor sensing probe, the floor sensing probe must be installed at this stage.
  - The floor probe (temperature sensor) is to be laid as far into the centre of the floor as possible (positioned exactly between 2 runs of heating elements - this is very important for accuracy of temperature control), still ensuring that the floor probe lead (3 metres in length) can reach the controller position up the wall.

## Installation Step 6 - Cover the heating element with thermal screed

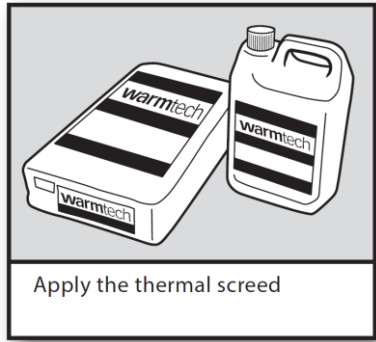

- Fit the power supply cables into the channels and secure with fixing tape. Remove all debris and chippings from the floor.
- Check the subfloor, as certain floor may require priming prior to the levelling screed being laid.
- Mix and apply the screed as per the manufacturer's instructions.
- Depending on your tiler's requirements, they may wish to apply a self levelling screed over the heating elements for ease of tiling.
- Allow 24-48 hours before commencing tiling.

## Installation Step 7 - Testing of the heater (Prior to and during tiling/tiling procedures)

Your Warmtech Undertile heater has been comprehensively tested prior to sale. You should retest the heater by using the following method.

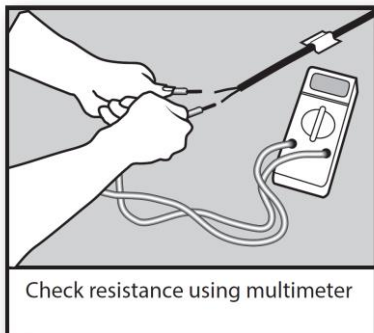

- Check the resistance on the heater, using a multi meter and confirm the reading against factory specifications (label on the cardboard spool).
- Test the heating element using an insulation tester (min. Voltage 500V)
- Connect the continuity tester (supplied with each heating element). Follow the connection instructions.
- **If the alarm sounds during the tiling procedure, stop all work and call Warmtech on 1300 138 126.**
- After the tiling and grouting procedure has been completed, the checks 1 and 2 need to be repeated.



## Installation Step 8 - Connection and testing of the Continuity alarm



- Ensure that the batteries are correctly installed.
- Test by turning the switch to the ON position and ensure that the audible alarm sounds. If the alarm sound cannot be heard, please call 1300 138 126 for technical assistance.
- Turn to the OFF position during connection to the heating element, and then turn it ON.

Note: When the heating element is connected to the tester and turned ON, there should be no alarm sound audible.

## Installation Step 9 - Tiling

The thickness of covering materials shall be at least 5mm.

The maximum thermal resistance between the heating unit and the room is 0.333per sqm K/W.

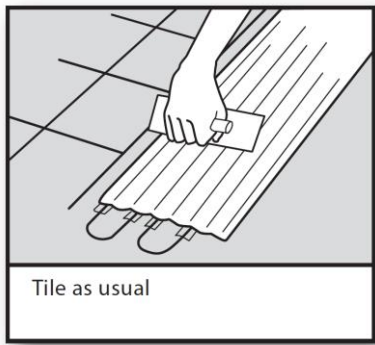
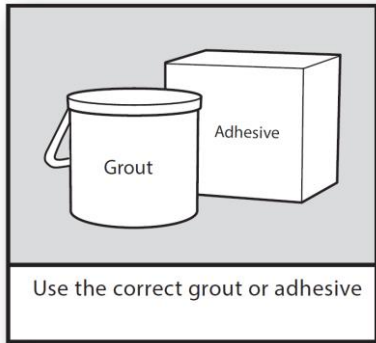

- The tile adhesive and grout should be suitable for use with underfloor heating. For further information refer to the Technical Notes section on Page 9.
- Where possible when tiling, gently comb the adhesive in straight lines in the same direction as the runs of the heating element. If possible use a plastic trowel. Where possible, combing the adhesive at right angles to the element should be avoided.
- Use sufficient adhesive to ensure that there are no voids or hollows under the tile.
- If a tile has been positioned incorrectly, care should be taken not to damage the heating element when lifting the tile.
- Do not store or cut tiles on top of the heater. Do not allow chippings or dust to contaminate the floor during tiling. Care must be taken not to damage the heating element during the tiling process.
- Use a piece of carpet or cardboard as a 'crawl board' to prevent the heater being damaged by your feet or knees during the tiling process.
- If possible, periodically test the heater during tiling. If the heater is not working, **DO NOT CONTINUE**, call Warmtech Technical Support on 1300 138 126.

- Grout the floor as soon as possible as per the adhesive manufacturer's instructions (**Extra care should be taken when cleaning between the tiles prior to grouting**).
- Do not switch on the heater until the tile adhesive has fully cured (7-10 days).

### **Installation Step 10 - Controller Connection**

Once the heater and controller have been installed and the tile adhesive has cured, all electrical circuit wiring and connection of this appliance must be undertaken in accordance with current electrical standards and practices.

#### **Note:**

- Your Warmtech heating element has been classified as an electrical appliance.
- You are therefore not required to be an electrician to install (lay out) the element. All electrical connections including the connection of the controller must be undertaken by a licensed electrician.
- Means shall be provided to ensure all-pole disconnection from supply.

**Ensure all electrical supply circuits to the heating elements are protected via a RCD (Residual Current Device) protected circuit.**

**If you have upgraded your controller, then please refer directly to that controller for wiring details.**

#### **Operation**

Once the heater and controller have been installed and the tile adhesive has cured, the heater can be switched on. Initial heat up time will vary depending upon the age of the floor, floor type (concrete or timber), time of year, thermal characteristics and insulation of your sub floor. These heat up times will improve with increased usage.

Ensure your Electrician reads through the instructions as supplied with the thermostat before connecting the thermostat.

## Tiler Instructions

This floor has been fitted with a Warmtech undertile heater. Please read the following tips to ensure safe tiling and prevent accidental damage to the heater.

(The heating element is a double insulated multi-stranded element and is designed to withstand normal tiling practices. We do ask that you take special care to ensure its integrity. **Additional care should be taken after tiling when cleaning out between the tiles prior to grouting.** This is when you are most likely to cause damage to the heating element).

The element is adhered to the floor with a combination of adhesive tape and concentrated latex (SBR type) adhesive. The floor must not be walked over until the adhesive has dried clear (24 hours depending upon the ambient room temperature).

With care you can tile directly over the element. We have found that using a thin bed application method with a 10mm-12mm notched trowel works best. It is recommended that all elements are covered with a leveling screed or diluted mix of the tile adhesive to be used - to ease tile installation and further reduce the chance of accidental damage. Either way a flexible adhesive must be used. Latex modified (acrylic, PVA, SBR) cement based grout should be used with at least a 10% "by weight of solids based" content of latex.

If waterproofing is required but has not been installed prior to the heating installation, it may be possible to waterproof over the heating elements. Confirmation regarding its acceptability to be installed over the heating should be obtained from the waterproofing supplier.

Common practices that will cause heater damage and should be avoided at all cost are:

- Cutting tiles over the heating or within the area to be heated.
- Dropping tools on the heating elements.
- Wearing inappropriate footwear (soft soled shoes or socks are ideal).
- Lifting of misplaced or damaged tiles.
- Removing excess adhesive from between tiles (by scraping between them).
- Removing plastic spacers.
- Twisting and turning excessively over the heating elements.
- Excessive foot traffic.
- Other trades working over the installed heating elements before tiling.

## **PRODUCT WARRANTY UNDERTILE HEATING ELEMENTS**

We warrant you that the new Warmtech heating equipment with this warranty is free from any manufacturing defects.

This warranty applies to **Warmtech Undertile Heating** elements for a period of two (2) years from the date of purchase.

**Warmtech** reserves the right to repair or offer a full refund (money back) to the value of the heating kit only, in the event of malfunctioning of the heating within the two (2) year warranty period as a result of a manufacturing defect.

**Warmtech** or its Distributors reserve the right to charge for any repairs/faults tracing caused by installation damage which is not the fault of **warmtech Heating Systems**.

All procedures as detailed in the installation manual need to be followed for this warranty to be valid. Any deviation from these may result in the warranty being null and void.

Attach your proof of purchase and keep in a safe place with this warranty form.