

1 Parts

- One (1) thermostat
- One (1) floor sensor
- One (1) wall plate

2 Guidelines

Turn off power to the heating system at the main power panel to avoid electrical shock. Installation should be carried out by an electrician.

- ▶ All work must conform to the applicable country standards for electrical installations and wiring.
- ▶ This thermostat should be connected on a circuit equipped with a fuse or a circuit breaker. It must be installed on a certified electrical box equipped with non-metallic cable strain relief adapters. Use separate adapters for the high-voltage wires and for the sensor cable.
- ▶ For a new installation, choose a location about 1.5 m above the floor.
- ▶ For electric baseboards, convectors and fan-forced heaters, the thermostat must be installed facing the heating system and on an inside wall.
- ▶ Avoid locations where there are air drafts (top of staircase, air outlet), dead air spots (behind a door), direct sunlight or concealed chimneys or stove pipes.

NOTE: The terminals are designed to handle a cross-section of wire measuring 0.33 to 3.1 mm².

3 Procedure

- Loosen the captive screw underneath the base and remove the faceplate from the base.

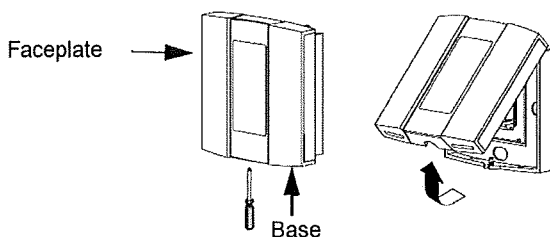

- Before making the connections, make sure that the base covers the electrical box entirely. If not, install a wall plate at the back of the base.

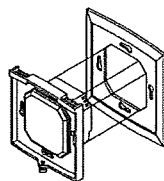

- Connect the wires:

- **Power:**
Terminals 1 & 5
- **Load:**
Terminals 2 & 4
see note 1
- **Pilot Wire:**
Terminal 3
see note 2
- **Floor sensor:**
Terminals 6 & 7
(no polarity)
see note 3

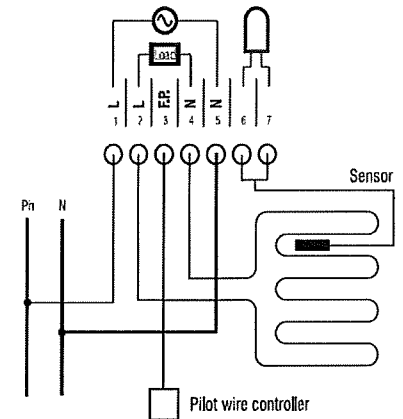

WARNING: Ensure that the wires are tightly secured to the terminals. Apply a minimum torque of 0.5 Nm (4.4 Lb/in) when tightening the screws.

Note 1 If a contactor is used between the thermostat and the load, install a snubber at the contactor's coil terminal to ensure the proper operation of the thermostat.

Note 2 This connection is required on some models only.

Note 3 The sensor cable must pass outside the electrical box and travel inside the wall to the floor. For the proper operation of the thermostat, the floor sensor must be centered between two heater wires having a maximum temperature of 80 °C (176 °F). The floor sensor wire must not cross any heater wire or be placed close to it.

- Push wires into the electrical box and secure the base to the electrical box anchorage. The head of the screw must be less than 2 mm thick.

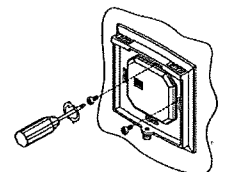

- Return the faceplate to the base.

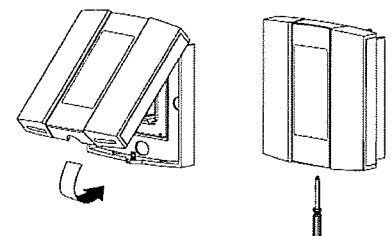

- Return power to the heating system.

NOTE: Keep the thermostat's air vents clean and unobstructed at all times.

1 Description

This thermostat incorporates both a mechanical relay and a triac and thus has a much longer life span than a thermostat that uses a mechanical relay only. It provides the following temperature control modes:

- A mode:** ▶ controls and displays the ambient air temperature

- F mode:** ▶ controls and displays the floor temperature using an external temperature sensor (default mode)

- AF mode:**
 - ▶ controls and displays the ambient air temperature
 - ▶ maintains the floor temperature within desired limits using an external temperature sensor

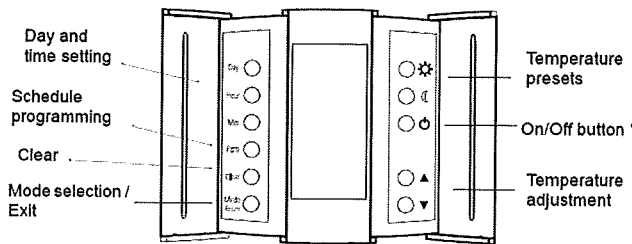

* Use this button to disable heating (e.g. in the summer). The thermostat remains powered and continues to display the time and temperature.

Display

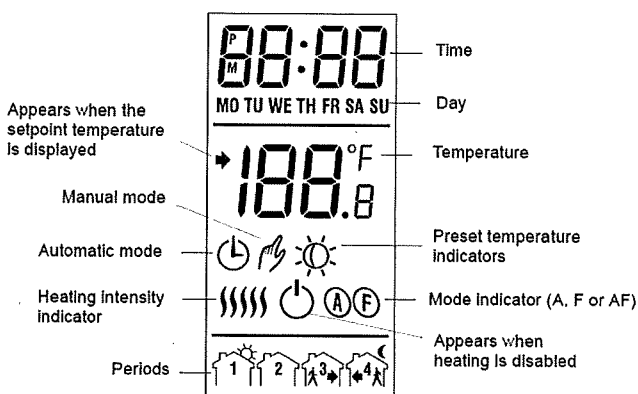

2 Power Up

Apply power to the thermostat at the main electrical panel. At power-up, the thermostat is in manual mode M and displays the actual (measured) temperature. The setpoint temperature is 28 °C (82 °F).

3 Error Messages

- LO** The actual temperature is below 0 °C (32 °F).
- HI** The actual temperature is above 70 °C (158 °F).
- Er** The thermostat built-in sensor is defective. Replace the thermostat.
- E1** The floor sensor circuit is opened. Check the sensor connections.
- E2** The floor sensor circuit is shorted. Replace the sensor.

4 Configuration

4.1 Control Mode Selection

- 1 Press and hold the **Clear** button for 3 seconds. The current control mode is displayed (ctl).
- 2 Press the $\blacktriangle/\blacktriangledown$ to select between **A**, **AF** and **F**.

NOTE: If you have chosen the **A** or **F** mode, go to step 7. If you have chosen the **AF** mode, the thermostat will control the ambient temperature while keeping the floor temperature within desired limits. If the floor temperature is too low or too high, the thermostat will turn heating on or off to maintain the floor temperature within the limits regardless of the ambient temperature. The minimum and maximum floor temperature limits are factory-set at 5 °C (41 °F) and 28 °C (82 °F) respectively. To modify the limits, continue with the next step:

- 3 Press the **Clear** button briefly. The minimum limit is displayed (FL:LO).
- 4 Press the $\blacktriangle/\blacktriangledown$ button to set the minimum limit.
- 5 Press the **Clear** button briefly. The maximum limit is displayed (FL:HI).
- 6 Press the $\blacktriangle/\blacktriangledown$ buttons to set the maximum limit.
- 7 Press the **Mode/Return** button to exit and save the changes.

NOTE: If no button is pressed for 60 seconds, the thermostat will save the changes and return to normal display.

4.2 Other Configurations

This procedure allows you to choose the following configurations:

Parameters	Default settings
Temperature format	°C
Time format	24H
Early Start setting (see the note below)	On

- 1 Press and hold the **Pgm** button for 3 seconds. The current temperature unit is displayed (unit).
- 2 Press the $\blacktriangle/\blacktriangledown$ to toggle between °C and °F.
- 3 Press the **Pgm** button briefly. The current time format is displayed (Hr).
- 4 Press the $\blacktriangle/\blacktriangledown$ to toggle between 24H and 12H.
- 5 Press the **Pgm** button briefly. The current Early Start setting is displayed (ES).

- ⑥ Press the ▲▼ to toggle between OFF and On.
- ⑦ Press the **Mode/Return** button to exit and save the changes.

NOTE: Early Start can be used in Automatic mode only. When this function is set to On, the thermostat calculates the optimal time to start heating in order to obtain the desired temperature by the set time. The thermostat re-assesses the start time daily based on the previous day's results.

5 Clock and Day Setting

- ① Press the **Hour** button to set the hour.
- ② Set the **Min** button to set the minutes.
- ③ Set the **Day** button to set the day.
- ④ Press **Mode/Return** to exit and save the changes.

6 Temperature Adjustment

6.1 Setpoint Temperature

The thermostat normally displays the actual (measured) temperature. To view the setpoint, press one of the ▲▼ buttons once. The setpoint will appear for the next 5 seconds.

To change the setpoint, press one of the ▲▼ buttons until the desired temperature is displayed. To scroll faster, press and hold the button.

Backlight

The screen is lit for 12 seconds when any button is pressed.

6.2 Preset Temperatures

The thermostat has 2 preset temperatures:

- ▶ Comfort temperature ☼
- ▶ Economy temperature ☾

To use a preset temperature, press the corresponding button. The corresponding icon will be displayed.

The following table shows the intended use and the default value of each of the preset temperatures.

Icon	Intended use	A/AF modes	F mode
☼	Comfort (when at home)	21 °C (70 °F)	28 °C (82 °F)
☾	Economy (when asleep or away from home)	16.5 °C (62 °F)	20 °C (68 °F)

To store a preset temperature:

- ① Set the desired temperature using the ▲▼ buttons.
- ② Press and hold the corresponding temperature preset button until the corresponding icon is displayed.

7 Modes of Operation

The thermostat has 2 modes of operation: automatic mode and manual mode.

7.1 Automatic Mode ☽

Use automatic mode if you want the thermostat to follow the programmed schedule. The schedule has 4 time periods and uses the 2 preset temperatures. The thermostat switches to Comfort temperature in periods 1 and 3 and to Economy temperature in periods 2 and 4. The following table shows the intended use of each time period.

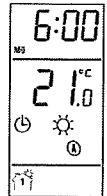

Period	Temperature setting	Typical use
☼	Comfort ☼	Wake-up
☾	Economy ☾	At work
☼	Comfort ☼	At home
☾	Economy ☾	Sleep

To use the automatic mode, press the **Mode** button to display ☽ on the screen. The current period number will also appear.

Preprogrammed schedule

The thermostat has been programmed with the following schedule.

Period	Temperature setting	Period start time						
		MO	TU	WE	TH	FR	SA	SU
☼	Comfort ☼	6:00 am	6:00 am	6:00 am	6:00 am	6:00 am	6:00 am	6:00 am
☾	Economy ☾	8:30 am	8:30 am	8:30 am	8:30 am	8:30 am	--:--	--:--
☼	Comfort ☼	4:00 pm	4:00 pm	4:00 pm	4:00 pm	4:00 pm	--:--	--:--
☾	Economy ☾	11:00 pm	11:00 pm	11:00 pm	11:00 pm	11:00 pm	11:00 pm	11:00 pm

Temporary bypass

You can override the temperature of the current period by pressing the ▲▼, ☼ or ☾ buttons. The new setpoint will be used until the beginning of the next period. The clock icon ☽ flashes during the bypass.

To cancel the bypass, press the **Mode** button.

Customizing the schedule



You can program the thermostat to use either 2 or 4 periods each day. For example, you can use 4 periods on weekdays and 2 periods on weekends. If you want to use 2 periods, choose periods "1 and 4" or periods "2 and 3". Early Start will not work if you choose periods "1 and 2" or periods "3 and 4".

- 1 Press **Pgm**. Period 1 of Monday is displayed.
- 2 If you wish to select another day, press **Day** repeatedly until the desired day is displayed.
NOTE: To select all 7 days, hold the Day button for 3 seconds. This function is helpful if you want the same program every day. When all 7 days are selected, the start time of the displayed period will be applied to all 7 days.
- 3 If you wish to select another period, press **Pgm** repeatedly until the desired period is displayed.
- 4 Press **Hour** and **Min** to set the period start time.
NOTE: To skip the period, press Clear. The thermostat will display --:-- to indicate that the period will not be used.
- 5 To program another period, go back to step 2.
- 6 Press **Mode/Return** to exit.

NOTE: If no button is pressed for 60 seconds, the thermostat will save the changes and return to normal display.

7.2 Manual Mode

In manual mode, the programmed schedule is not used. Use this mode if you wish to set the temperature manually or keep the same temperature all the time. To use the manual mode:

- 1 Press the **Mode** button to display .
- 2 Set the temperature using the **▲▼** buttons or select one of the preset temperatures by pressing the  or  button.

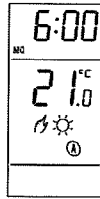

8 Technical Specifications

Supply: 230 VAC, 50 Hz

Maximum Load: 16 A or 3450 Watts (NI)

Rated Impulse: 2500 V

Ambient temperature

setpoint range (A/AF models): 5 °C to 30 °C (40 °F to 86 °F)

Floor temperature

setpoint range (F model): 5 °C to 40 °C (40 °F to 104 °F)

Floor temperature

limit range (AF model): 5 °C to 40 °C (40 °F to 104 °F)

Temperature display range: 0 °C to 70 °C (32 °F to 158 °F)

Temperature display resolution: 0.5 °C (1 °F)

Operating temperature: 0 °C to 50 °C (32 °F to 120 °F)

Storage temperature: -20 °C to 50 °C (-4 °F to 120 °F)

Heating cycle length: 15 minutes

Software: Class A

Automatic action: Type 1B and 1Y

Protection Index: IP21

Conformity: EN60730-1 / EN50081-1 / EN50082-2

Protection: Class 2

Environment: Normally polluted

Power outage: All programs and temperature settings are saved during a power outage. The clock must be reprogrammed if the power outage lasts more than 4 hours. When power returns, the thermostat returns to the mode of operation preceding the outage.

8 Warranty

TWELVE (12) MONTH WARRANTY

This product is warranted against defects in material and workmanship under normal conditions of use for a period of twelve months from the date of purchase. During this period, Warmtech will repair or replace the product, if it is defective in normal operating conditions in terms of materials or workmanship, with a new product of equivalent quality at Warmtech's option. The warranty does not cover costs of transportation, removal, installation or damage caused by misuse or accident. In no event will Warmtech be liable for consequential loss resulting from the installation of the product. Any defective product should be sent with the original invoice to the original installer, or shipped prepaid, insured and sent to Warmtech.

9 Customer Assistance

Phone: 1300 138 126

Email: info@warmtech.com.au

Website: www.warmtech.com.au